

Dimension Information:

Pos.	Dim A	Dim B	Dim C	Circuits	Dim A	Dim B	Dim C
2	5.4	—	9.4	14	30.6	25.2	34.6
4	9.6	4.2	13.6	16	34.8	29.4	38.8
6	13.8	8.4	17.8	18	39.0	33.6	43.0
8	18.0	12.6	22.0	20	43.2	37.8	47.2
10	22.2	16.8	26.2	22	47.4	42.0	51.4
12	26.4	21.0	30.4	24	51.6	46.2	55.6

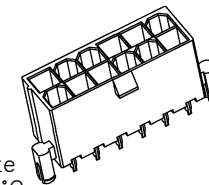

Specifications:  
 Current Rating:9.0A AC/DC  
 Voltage Rating:600V AC/DC  
 Contact Resistance:10m ohm. Max.  
 Insulation Resistance:1000M ohm. Min.  
 Withstanding Voltage:1500V AC For One Minute  
 Operating Temperature Range:-40°C To +105°C



Materials:  
 Insulator:Nylon 66 (UL94V-2;UL94V-0)  
 Insulator Color:Natural or Black  
 Contact:Brass  
 Plating:Tin Plated or Gold Plated

How To Order:  
 2266S-XXX-PG-XX-VX-XX  
 Blank Halogen  
 HF:Halogen-Free  
 F4A:Meet The GWT  
 Blank V2 Material(Transparent)  
 V0:V0 Material(White)  
 Blank Natural  
 BK:Black  
 PG:With Peg  
 Blank Tin Plated  
 G:Gold Plated  
 No. of Contacts  
 S:Straight Type Double Row

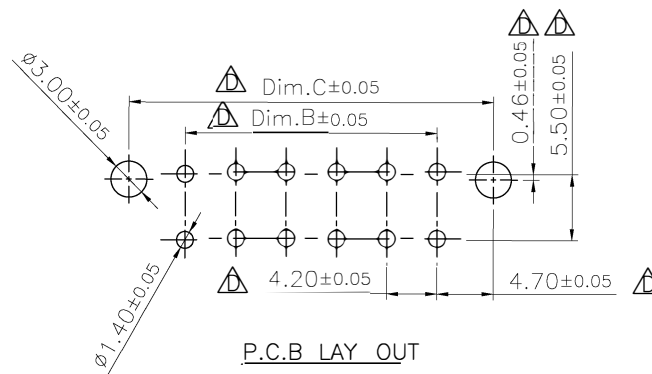

RoHS Compliant

F	12-NOV-2021	Add F4A&BK Option	Lisy Liu
E	19-OCT-2021	Modify Carton Size	Lisy Liu
D	22-JUN-2020		Lisy Liu
C	16-NOV-2016	ECN-TW1611001	Jamie Wang
B	03-MAR-2016	ECN-TW1603001	Justin Ho
A	06-APR-2007	-	Andrew
REV	DATE	FILE	BY

DRAWN: Justin Ho  
 CHECKED: Jerry Chen  
 APPROVAL: Andrew  
 Mike Wu

GENERAL TOLERANCE:  
 .X=±0.40  
 .XX=±0.30  
 UNIT: MM  
 SCALE:  
 SHEET: 1/3  
 PROJECTION:

**Neltron Connectors**  
**Neltron Industrial Co., Ltd.**  
 DESCRIPTION: 4.2mm Power Wafer Double Rows With Post Straight Type  
 PART NO: 2266S-XXX-PG-XX-VX-XX

SIZE  
**A4**

1

2

3



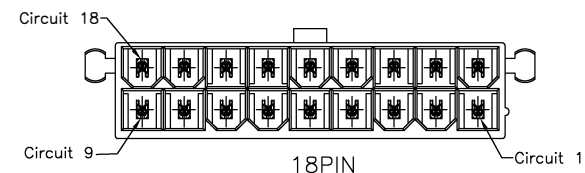
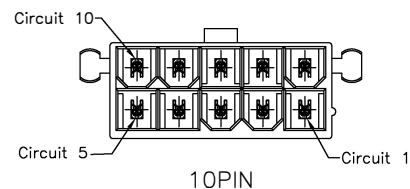
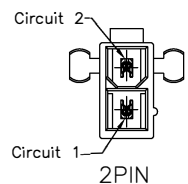
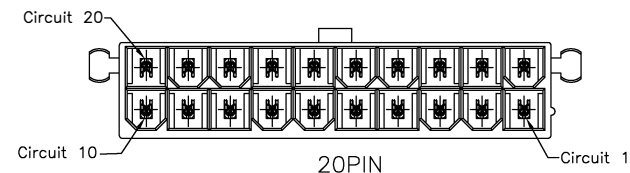
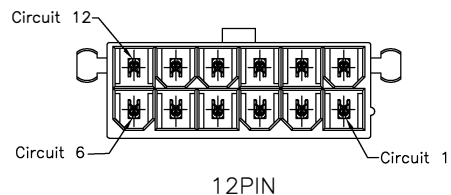
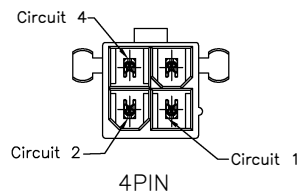
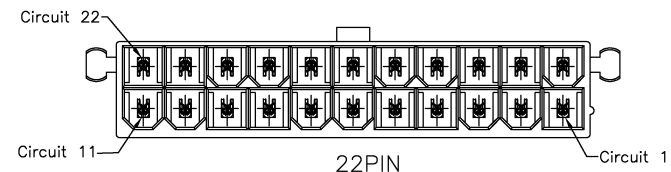
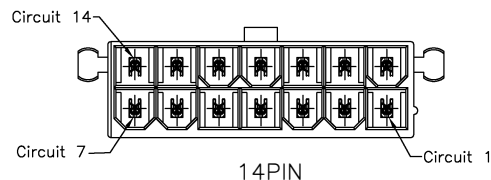
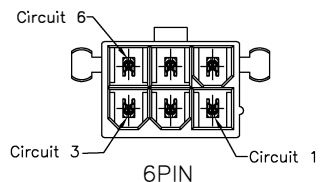
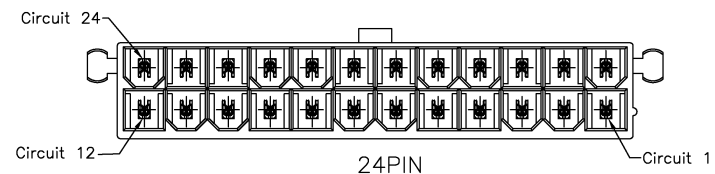
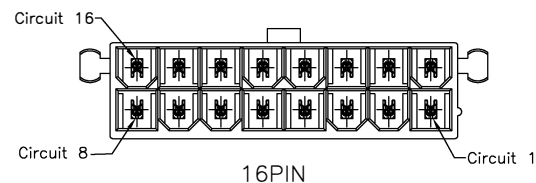
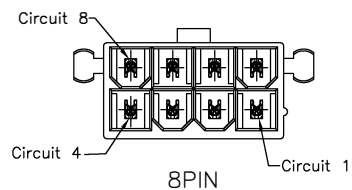

4

5



2~24P Protection Key Drawing(Ref.)

RoHS Compliant

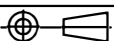
F	12-NOV-2021	Add F4A&BK Option	Lisy Liu	DRAWN: Justin Ho	GENERAL TOLERANCE: .X=±0.40 .XX=±0.30	 <b>Neltron Industrial Co., Ltd.</b>	DESCRIPTION: 4.2mm Power Wafer Double Rows With Post Straight Type	SIZE
E	19-OCT-2021	Modify Carton Size	Lisy Liu					
D	22-JUN-2020		Lisy Liu	CHECKED: Jerry Chen	UNIT: MM	PART NO: 2266S-XXX-PG-XX-VX-XX	 	<b>A4</b>
C	16-NOV-2016	ECN-TW1611001	Jamie Wang		SCALE:			
B	03-MAR-2016	ECN-TW1603001	Justin Ho	APPROVAL: Mike Wu	SHEET: 2/3			D
A	06-APR-2007	-	Andrew		PROJECTION:			
REV	DATE	FILE	BY					

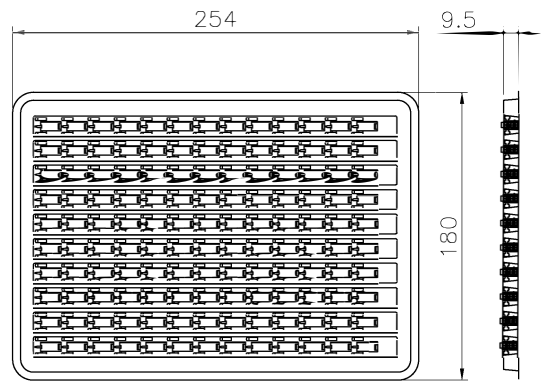
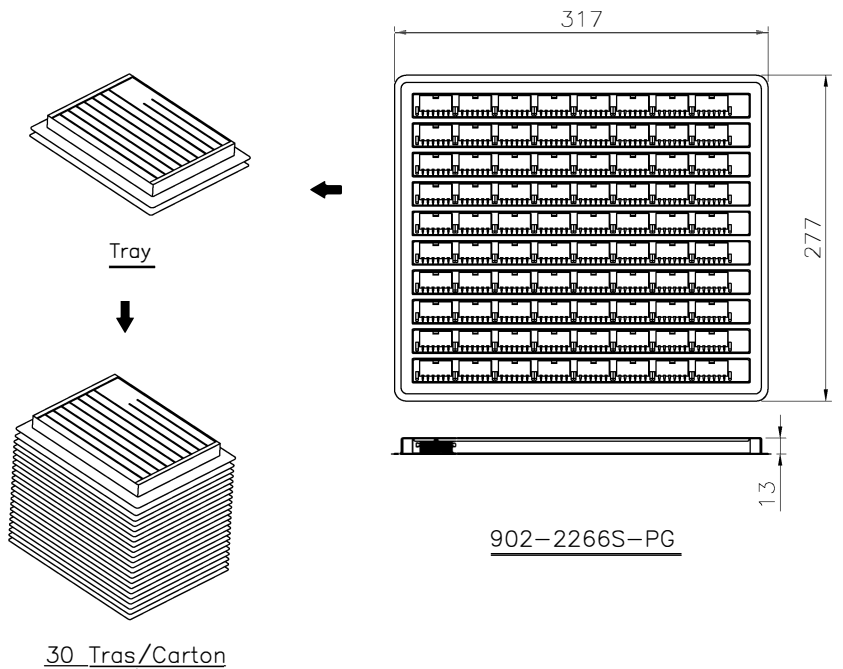

Note:  
 1.Dimension:  
 Tray Size:  
 317(L)x277(W)x13(H) (mm) (04~24Pin)  
 254(L)\*180(W)\*9.5(H) (mm) (2Pin Only)  
 Inner Carton Size:  
 263(L)\*190(W)\*260(H) (mm) (2Pin Only)  
 Carton Size:  
 320(L)x290(W)x380(H) (mm)  
 400\*280\*280 (mm) (2Pin Only)  
 2.Quantity:  
 XXPcs/Tray  
 XXPcs/Inner Carton(2Pin Only)  
 XXTrays/Carton

2Pin Only:  
 902-2212S(Bottom)  
 (With 902-2214S-85 Flat Cover)

Pin.	Pcs/Tray	Pcs/Inner	Pcs/Carton
2	170	3400	6800

Pin.	Pcs/Tray	Tray/Carton	Pcs/Carton
4	170	30	5100
6	130	30	3900
8	110	30	3300
10	90	30	2700
12	80	30	2400
14	70	30	2100
16	60	30	1800
18	60	30	1800
20	50	30	1500
22	50	30	1500
24	40	30	1200

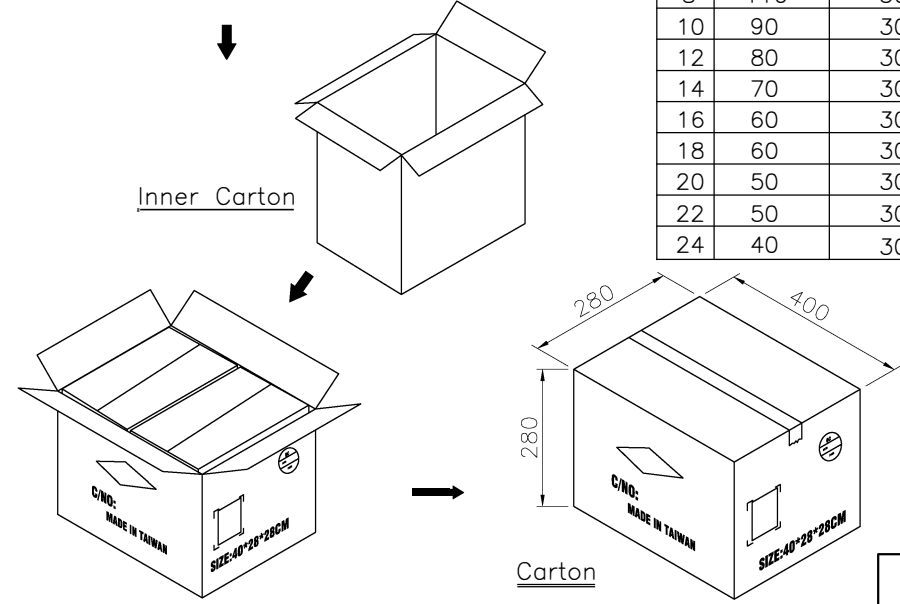
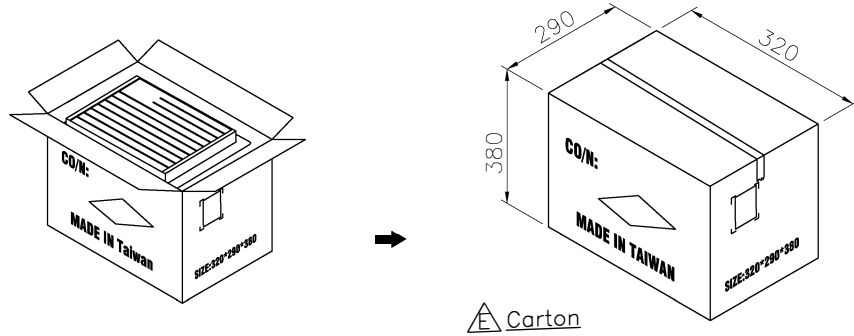

RoHS Compliant

F	12-NOV-2021	Add F4A&BK Option	Lisy Liu
E	19-OCT-2021	Modify Carton Size	Lisy Liu
D	22-JUN-2020	△	Lisy Liu
C	16-NOV-2016	ECN-TW1611001	Jamie Wang
B	03-MAR-2016	ECN-TW1603001	Justin Ho
A	06-APR-2007	-	Andrew
REV	DATE	FILE	BY

DRAWN:	GENERAL TOLERANCE:
Justin Ho	.X=±0.40 .XX=±0.30 △
CHECKED:	UNIT: MM
Jerry Chen	SCALE:
APPROVAL:	SHEET: 3/3
Mike Wu	PROJECTION: ⊕

**Neltron Connectors**

**Neltron Industrial Co., Ltd.**

DESCRIPTION: 4.2mm Power Wafer Double Rows With Post Straight Type Packing List

PART NO: 2266S-XXX-PG-XX-VX-XX △△

SIZE: **A4**