

1

2

3

4

5

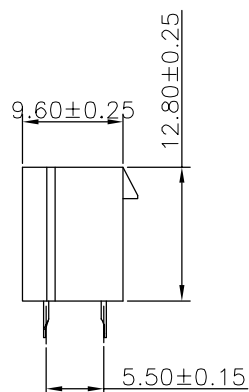
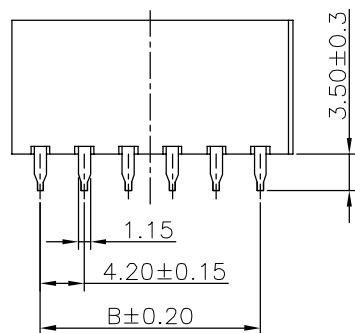
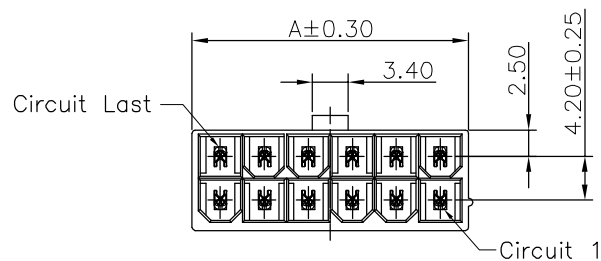

Specifications:

Current Rating:9.0A AC/DC
Voltage Rating:600V AC/DC
Contact Resistance:10m ohm. Max.
Insulation Resistance:1000M ohm. Min.
Withstanding Voltage:1500V AC For One Minute
Operating Temperature Range:-40°C To +105°C

Materials:

Insulator:Nylon 66 (UL94V-0)
Insulator Color:White
Terminal:Brass
Plating: Matte Tin Plated

How To Order:

2266S-XX-V0-F4A

UL94V-0
No. of Contacts
S:Staight Type Double Row

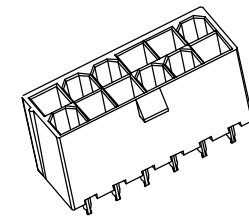

Dimension Information:

| Pin.No | Dim.A | Dim.B | Pin.No | Dim.A | Dim.B |
|--------|-------|-------|--------|-------|-------|
| 2 | 5.4 | — | 14 | 30.6 | 25.2 |
| 4 | 9.6 | 4.2 | 16 | 34.8 | 29.4 |
| 6 | 13.8 | 8.4 | 18 | 39.0 | 33.6 |
| 8 | 18.0 | 12.6 | 20 | 43.2 | 37.8 |
| 10 | 22.2 | 16.8 | 22 | 47.4 | 42.0 |
| 12 | 26.4 | 21.0 | 24 | 51.6 | 46.2 |

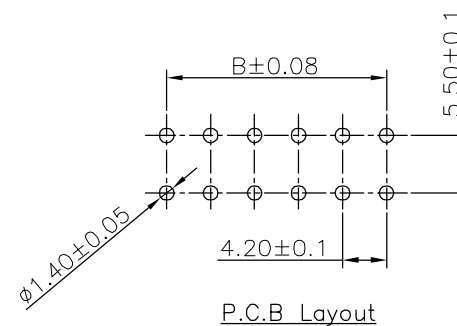

RoHS Compliant

| | | | | | | | | |
|-----|-------------|------|-----|-----------|-----------------------|-------------------------------------|---|-------------------|
| F | | | | DRAWN: | GENERAL TOLERANCE: | Neltron Industrial Co., Ltd. | DESCRIPTION: 4.2mm Power Wafer Double Rows Straight Type | SIZE A4 |
| E | | | | MEI | .X=±0.40 .XX=±0.30 | | | |
| D | | | | CHECKED: | UNIT: MM | PART NO: 2266S-XX-V0-F4A | | |
| C | | | | JERRY | SCALE: 1:1 | | | |
| B | | | | APPROVAL: | SHEET: 1/1 | | | |
| A | 28-Jul-2016 | | MEI | RORY | PROJECTION: | | | |
| REV | DATE | FILE | BY | | | | | |

1

2

3

4

5

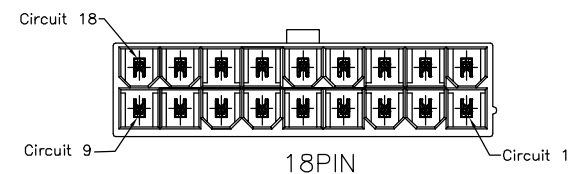
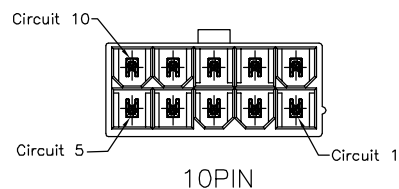
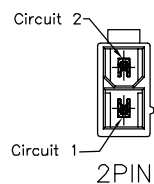
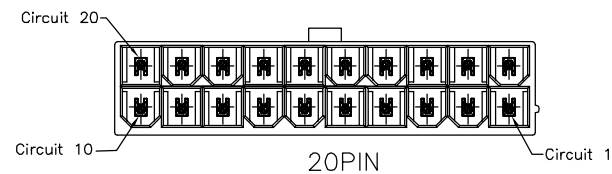
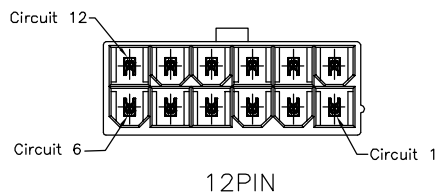
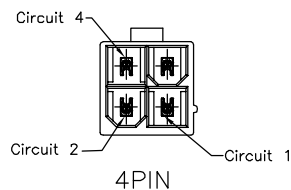
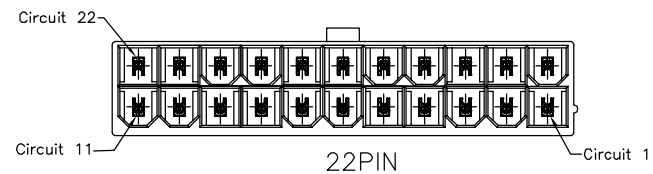
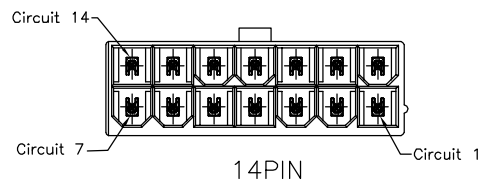
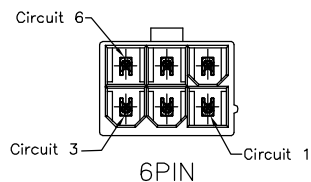
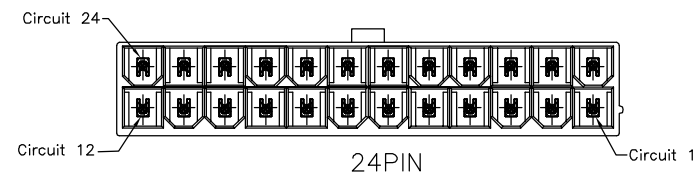
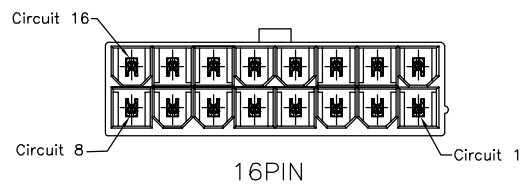
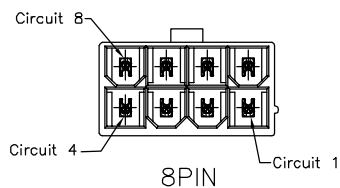

2~24P Protection Key Drawing(Ref.)

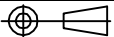
| | | | | | | | | |
|-----|-------------|------|-----|-------------------|---|---|---|------------|
| F | | | | DRAWN: MEI | GENERAL TOLERANCE: .X=±0.40 .XX=±0.30 |  Neltron Industrial Co., Ltd. | DESCRIPTION: 4.2mm Power Wafer Double Rows Straight Type | SIZE |
| E | | | | | | | | |
| D | | | | CHECKED: JERRY | SCALE: 1:1 | PART NO: 2266S-XX-V0-F4A | A4 | |
| C | | | | | APPROVAL: RORY | | | SHEET: 1/1 |
| B | | | | | PROJECTION:  | | | |
| A | 28-Jul-2016 | | MEI | | | | | |
| REV | DATE | FILE | BY | | | | | |