

Specifications:

Current Rating:1.5A AC/DC $\triangle B$
 Voltage Rating:30V AC/DC
 Contact Resistance:30m ohm. Max.
 Insulation Resistance:1,000M ohm. min.
 Withstanding Voltage:500V AC For One Minute
 Operating Temperature Range:-50°C ~ +85°C $\triangle B$

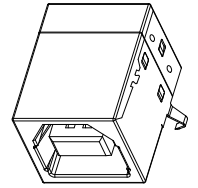

Material and Finish

Insulator:PBT or Nylon 9T or LCP (UL94V-0) $\triangle A$ $\triangle C$
 Contact:Phosphor Bronze
 Plating:Gold Plated on Contact Area,
 Tin Plated on Solder Tail.
 Shell:Brass,Nickel Plated
 Back Cover:SPCC, Matte Nickel Plated

How To Order

5075BR-04-XX-XX-XX

- Blank PBT
- F5:Nylon 9T $\triangle A$
- F7:LCP $\triangle C$
- Standard Selective Plated
- 03:Selective Gold Plated 3u" $\triangle A$
- 15:Selective Gold Plated 15u"
- 30:Selective Gold Plated 30u"
- BK:Black
- WH:White

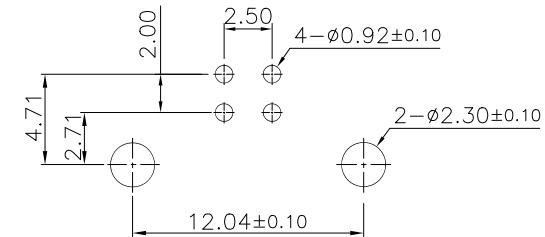

P.C.B Layout

RoHS Compliant

K				DRAWN:	GENERAL TOLERANCE:
J				Zhou	.X=±0.20
I				CHECKED:	.XX=±0.15
H	04-Jul-2024	Add Plated Option	Yizhen Lee	Jeremy Liu	UNIT: MM
G	30-Dec-2020	Add LCP	Jamie Wang		SCALE: 1:1
A	13-Jul-2011		Zhou	APPROVAL:	SHEET: 1/2
REV	DATE	FILE	BY	Mike Wu	PROJECTION:

Neltron Industrial Co., Ltd.

DESCRIPTION: USB B Type PCB Socket Right Angle Type	SIZE A4
PART NO: 5075BR-04-XX-XX-XX $\triangle A$	

1

2

3

4

5

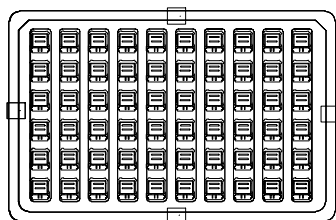
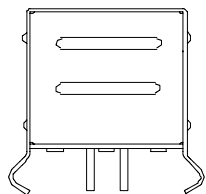

16*2 TRAY

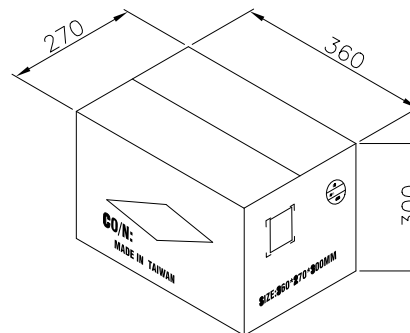
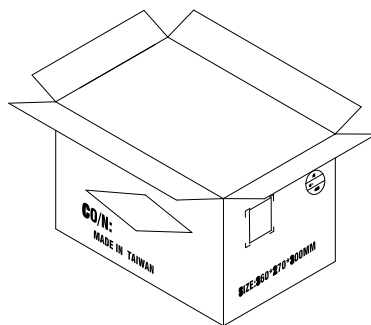

CARTON

Note:

1.Dimension:

Carton Size:360X270X300 (mm)



2.Qunntity:

60 Pcs/Tray

32 Tray/Carton

Q'TY: 1920pcs

RoHS Compliant

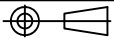
K				DRAWN:	GENERAL TOLERANCE:	 Neltron Industrial Co., Ltd.	SIZE
J				Zhou	.X=±0.20 .XX=±0.15		
I				CHECKED:	UNIT: MM	DESCRIPTION:	A4
H	04-Jul-2024	Add Plated Option	Yizhen Lee	Jeremy Liu	SCALE: 1:1		
G	30-Dec-2020	Add LCP	Jamie Wang	APPROVAL:	SHEET: 2/2	PART NO:	5075BR-04-XX-XX-XX 
A	13-Jul-2011		Zhou	Mike Wu	PROJECTION: 		
REV	DATE	FILE	BY				