

1

2

3

4

5

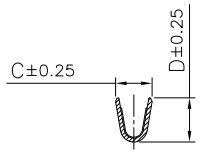
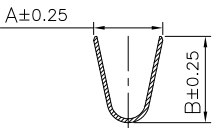
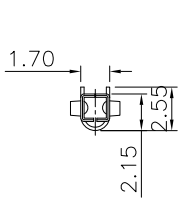
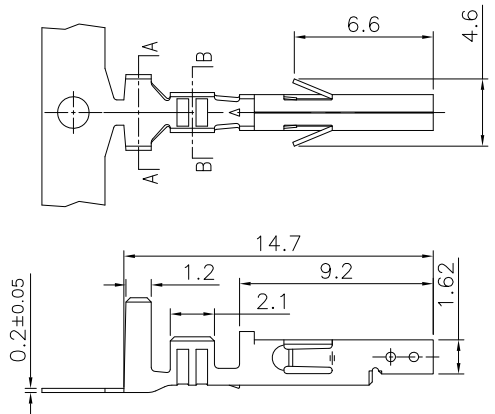

Part No	Wire Application	A	B	C	D
2257T-16-XX	16Awg	3.6	4.5	2.3	2.7
2257T-1824-XX	18~24Awg	3.6	4.5	1.9	2.3
2257T-2228-XX	22~28Awg	2.3	2.3	1.8	1.65

2257T-XXXX-XX

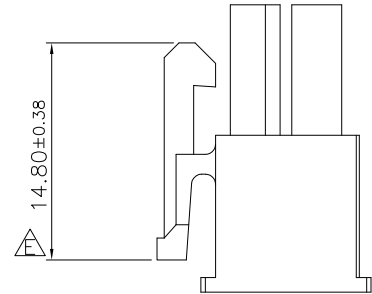
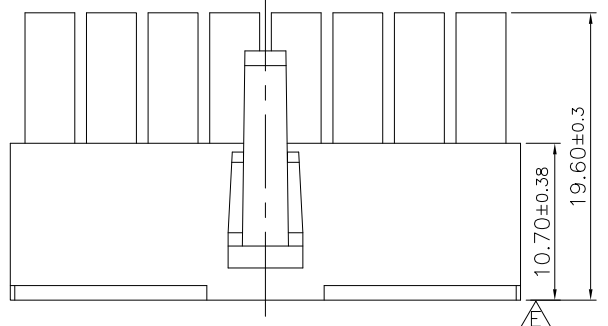
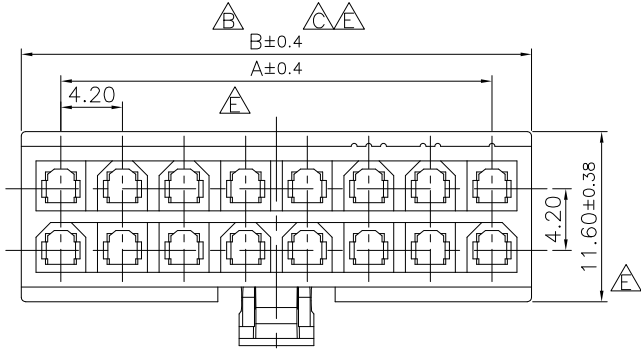

Specifications:  
 Current Rating:9.0A AC/DC  
 Voltage Rating:600V AC/DC  
 Contact Resistance:10m Ohm. Max.  
 Insulation Resistance:1,000M Ohm. Min.  
 Withstanding Voltage:1500V AC/Minute  
 Operating Temperature Range:-40°C ~ +105°C  
 Application Wire:Awg 16~28

Material And Finish:  
 Insulator:Nylon 66 (UL94V-0)  
 Color:White  
 Contact:Brass  
 Finish:Tin Plated  
 Part Is For Use With Neltron Female Terminal 2257T

How To Order  
 2257-XX-V0-XX  
 HF:Halogen-Free  
 F4A:SC21  
 V0:V0 Material  
 NO. of Contacts

Dimension:

Circuits	DIM.A	DIM.B	DIM.C
2		5.40	3.05
4	4.20	9.60	
6	8.40	13.80	
8	12.60	18.00	
10	16.80	22.20	
12	21.00	26.40	
14	25.20	30.60	
16	29.40	34.80	
18	33.60	39.00	
20	37.80	43.20	
22	42.00	47.40	
24	46.20	51.60	

A & B DIM. TOLERANCE:  
 2 ~ 8P: A±0.20 B±0.30  
 10~16P: A±0.30 B±0.40  
 18~24P: A±0.40 B±0.40



RoHS Compliant

F	30-MAR-2021	Add F4A Description	Lisy Liu
E	19-FEB-2019	ECN-TW1902004	Lisy Liu
D	18-OCT-2016	ECN-TW1610006	Jamie Wang
C	22-JUN-2016	ECN-TW1606006	Blake Huang
B	31-AUG-2015	ECN-TW1508007	Miller Yu
A	15-SEP-2014		Eisen
REV	DATE	FILE	BY

DRAWN:	Eisen
CHECKED:	Dennis Lin
APPROVAL:	Mike Wu

GENERAL TOLERANCE:	.X=±0.40 .XX=±0.30
UNIT:	MM
SCALE:	1:1
SHEET:	1/2
PROJECTION:	

<b>Neltron Industrial Co., Ltd.</b>	
DESCRIPTION:	4.2mm Receptacle Housing
PART NO:	2257-XX-V0-XX

SIZE	<b>A4</b>

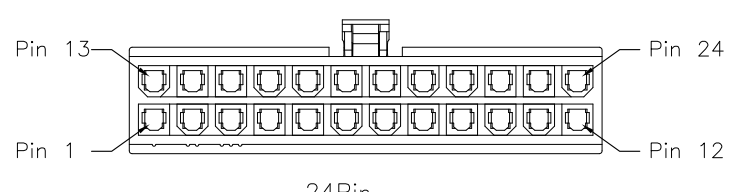
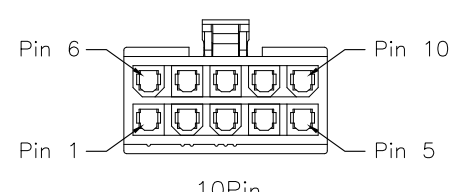
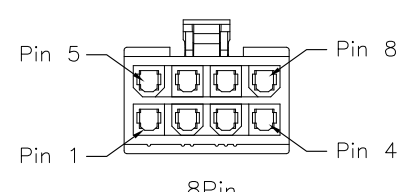
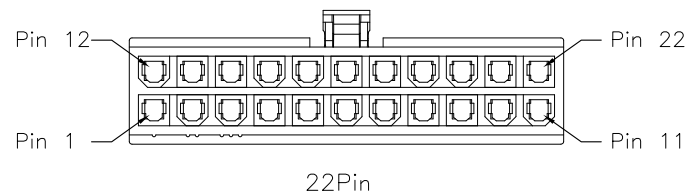
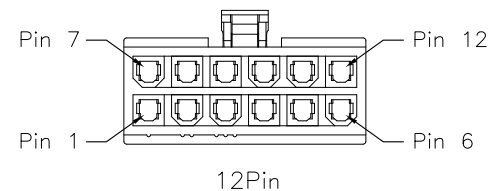
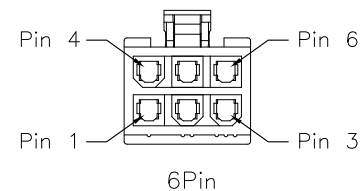
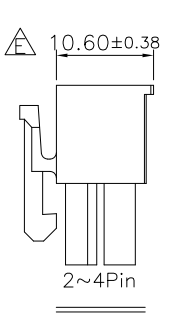
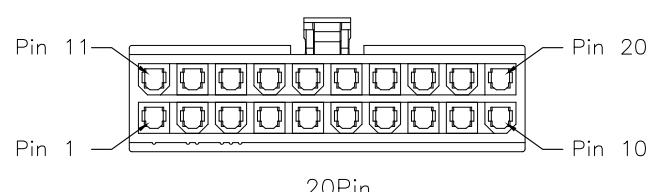
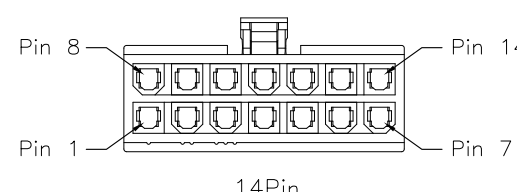
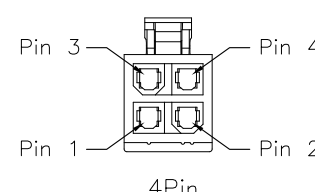
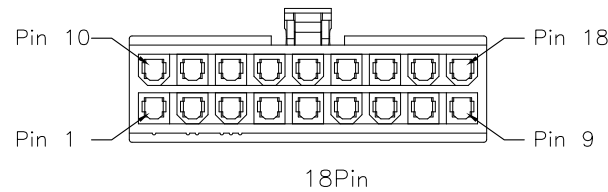
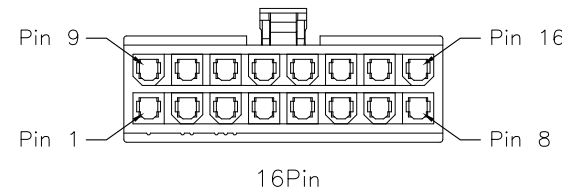
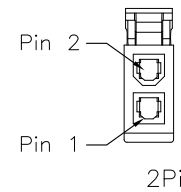
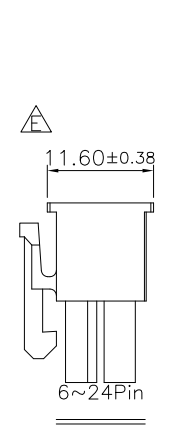

2~24Pin 防呆示意图(Ref.)

RoHS Compliant

F	30-MAR-2021	Add F4A Description	Lisy Liu	DRAWN: Eisen	GENERAL TOLERANCE: .X=±0.40 .XX=±0.30	<b>Neltron Industrial Co., Ltd.</b>	DESCRIPTION: 4.2mm Receptacle Housing	SIZE <b>A4</b>
E	19-FEB-2019	ECN-TW1902004	Lisy Liu					
D	18-OCT-2016	ECN-TW1610006	Jamie Wang	CHECKED: Dennis Lin	UNIT: MM	PART NO: 2257-XX-V0-XX	D	
C	22-JUN-2016	ECN-TW1606006	Blake Huang		SCALE: 1:1			
B	31-AUG-2015	ECN-TW1508007	Miller Yu	APPROVAL: Mike Wu	SHEET: 2/2	PROJECTION:		
A	15-SEP-2014		Eisen					
REV	DATE	FILE	BY					