

1

2

3

4

5

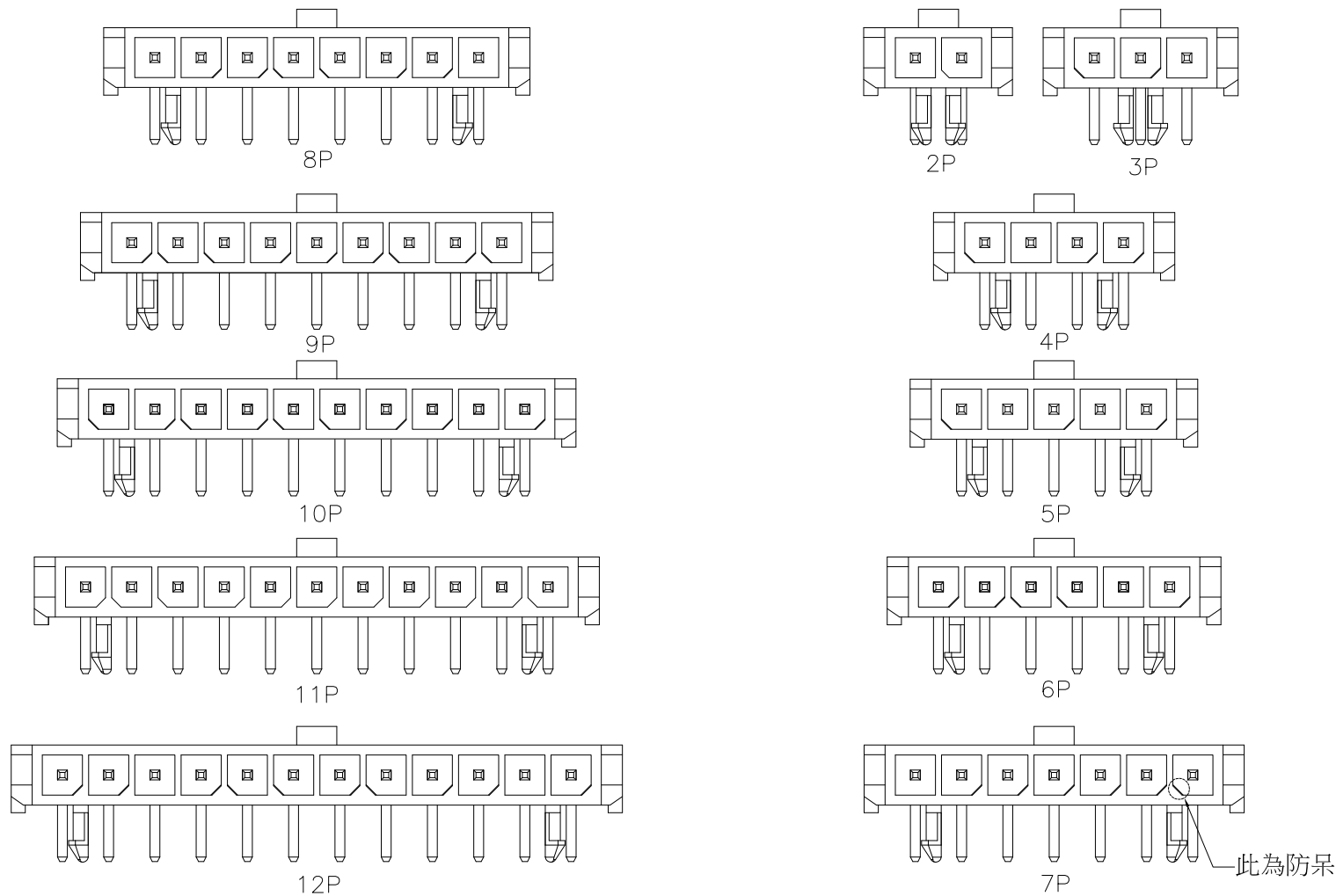

5561RA-XX (2-12)Pin防呆位置分部示意图

RoHS Compliant

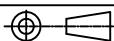
F				DRAWN: Pingchia	GENERAL TOLERANCE: .X=±0.10 .XX=±0.05 .XXX=±0.03	 Neltron Industrial Co., Ltd.	DESCRIPTION: 3.0mm Wafer Single Row 90° Type	SIZE A4
E			CHECKED: Jerry Chen					
D				APPROVAL: Mike Wu	SCALE:1:1	PART NO: 5561RA-XX		
C					SHEET: 2/2			
B					PROJECTION: 			
A	18-Oct-2016		Pingchia					
REV	DATE	FILE	BY					

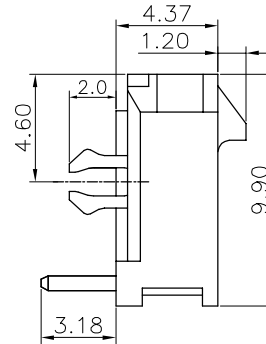
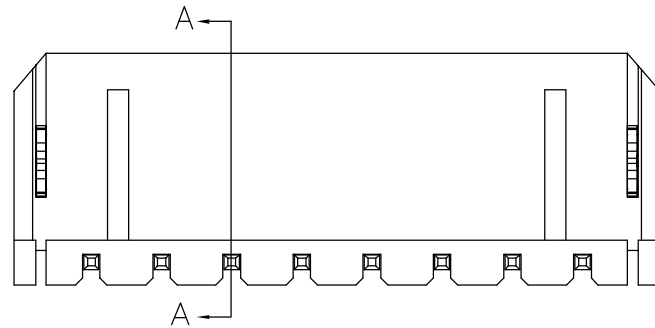
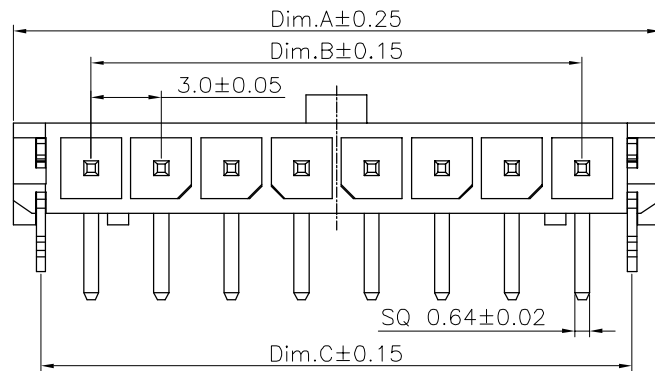

Positions	Dimension			Positions	Dimension		
	A	B	C		A	B	C
2	9.65	3.00	7.30	8	27.65	21.00	25.30
3	12.65	6.00	10.30	9	30.65	24.00	28.30
4	15.65	9.00	13.30	10	33.65	27.00	31.30
5	18.65	12.00	16.30	11	36.65	30.00	34.30
6	21.65	15.00	19.30	12	39.65	33.00	37.30
7	24.65	18.00	22.30				

Specifications:

Current rating:5.0Amps
 Voltage rating:250V AC,DC
 Contact resistance:10mohm Max
 Insulation resistance:1,000Mohm min.
 Withstanding voltage:1,500V AC;DC
 Operating Temperature range:-25°C ~ +105°C

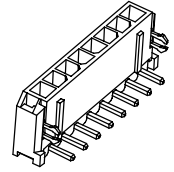

Materials:

Insulator:LCP(UL94V-0)
 Insulator Color:Black
 Contact:Copper Alloy
 Plating:Tin Plated

How to order
 5561RA-XX-A

└── Metal Board Lock
 └── No. Of Positions
 └── RA:Right Angle

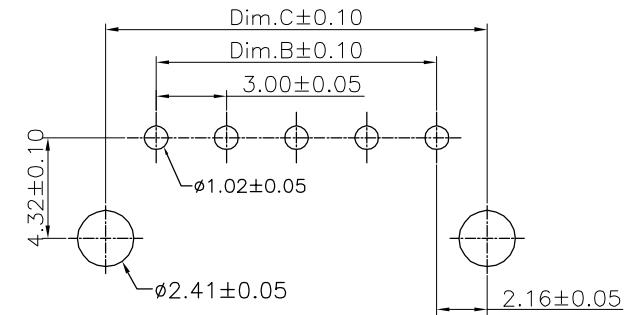

P.C.B Layout

RoHS Compliant

F				DRAWN: Pingchia	GENERAL TOLERANCE: .X=±0.20 .XX=±0.15	Neltron Industrial Co., Ltd.	DESCRIPTION: 3.0mm Wafer Single Row 90° Type	SIZE A4
E								
D				CHECKED: Jerry Chen	UNIT: MM	PART NO: 5561RA-XX-A		
C					SCALE:1:1			
B				APPROVAL: Mike Wu	SHEET: 1 / 2			
A	18-Oct-2016		Pingchia		PROJECTION:			
REV	DATE	FILE	BY					

1

2

3

4

5

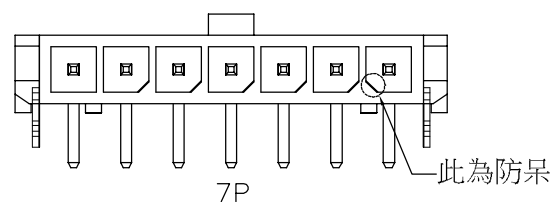
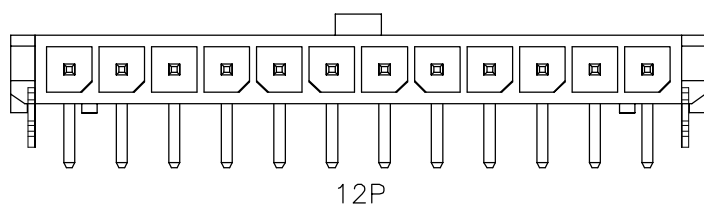
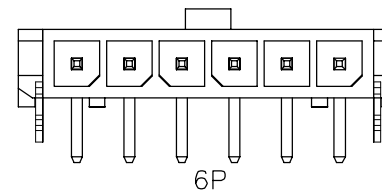
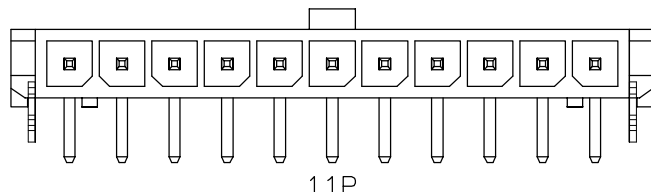
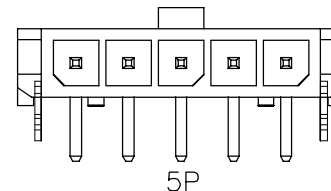
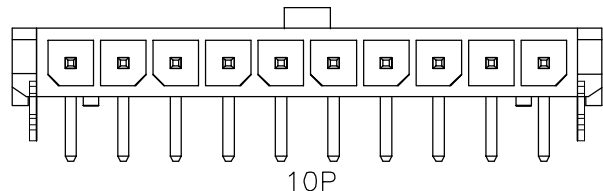
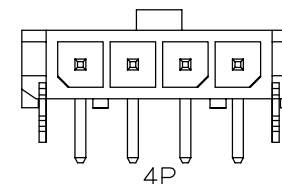
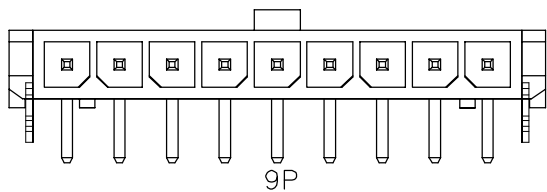
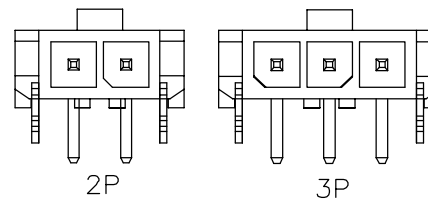
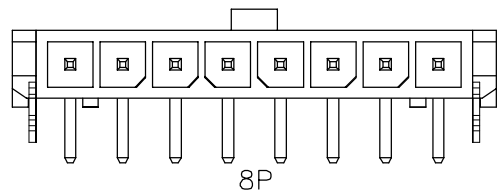

5561RA-XX-A (2-12)Pin防呆位置分部示意圖

RoHS Compliant

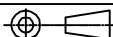
F				DRAWN:	GENERAL TOLERANCE:	 Neltron Industrial Co., Ltd.	SIZE
E				Pingchia	.X=±0.10		
D				CHECKED:	.XX=±0.05	DESCRIPTION:	3.0mm Wafer Single Row 90° Type
C				Jerry Chen	.XXX=±0.03		
B				APPROVAL:	UNIT: MM	PART NO:	A4
A	18-Oct-2016		Pingchia	Mike Wu	SCALE: 1:1		
REV	DATE	FILE	BY		SHEET: 2/2		
					PROJECTION:		

1

2

3

4

5

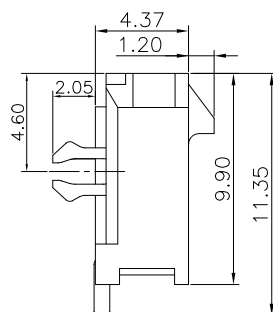
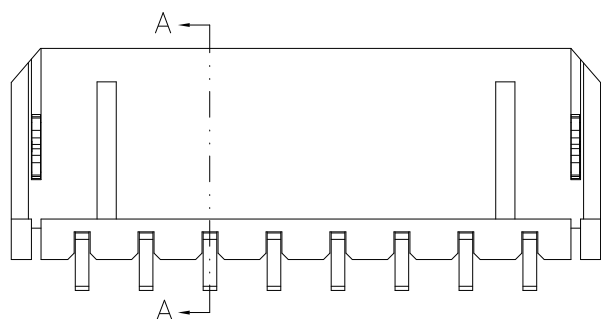
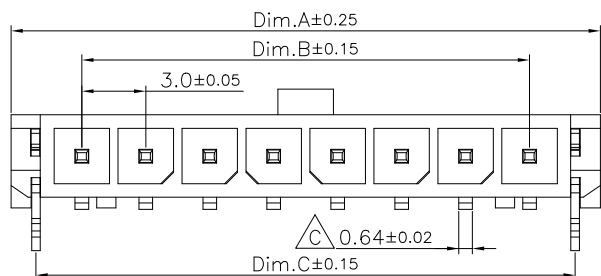

Specifications:

Current Rating: 5.0A AC,DC
 Voltage Rating: 250V AC,DC
 Contact Resistance: 10m ohm.Max
 Insulation Resistance: 1000M ohm.Min
 Withstanding Voltage: 1500V AC/Minute
 Operating Temperature Range: -25°C ~ +105°C

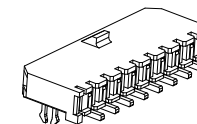

Material:

Insulator: LCP(UL94V-0)
 Insulator Color: Black
 Contact: Copper Alloy
 Plated: Tin or Selective Gold Plated \triangle_B

How To Order

5561RA-XXX-SM-XX

Blank Tube
 TR:Tape&Reel
 SMD Type
 T:Tin Plated
 SG15:Selective Gold Plated 15u"
 SG30:Selective Gold Plated 30u"
 No. of Contacts
 Right Angle Type

Positions	Dimension			Positions	Dimension		
	A	B	C		A	B	C
2	9.65	3.00	7.30	8	27.65	21.00	25.30
3	12.65	6.00	10.30	9	30.65	24.00	28.30
4	15.65	9.00	13.30	10	33.65	27.00	31.30
5	18.65	12.00	16.30	11	36.65	30.00	34.30
6	21.65	15.00	19.30	12	39.65	33.00	37.30
7	24.65	18.00	22.30				

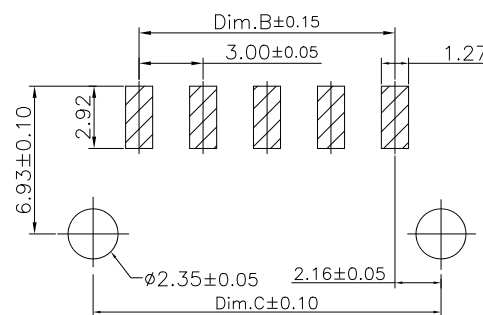

P.C.B Layout

RoHS Compliant

F				DRAWN: Miller Yu	GENERAL TOLERANCE: .X=±0.20 .XX=±0.15	Neltron Industrial Co., Ltd.	SIZE
E							
D				CHECKED: Jerry Chen	UNIT: MM	DESCRIPTION: 3.0mm Wafer Single Row SMD Type	A4
C	28-May-2024	\triangle_C	Lucy Du		SCALE: 1:1		
B	13-Jan-2023	\triangle_B add Selective Gold Plated Option	Andrew	APPROVAL: Mike Wu	SHEET: 1/2	PART NO: 5561RA-XXX-SM-XX	
A	29-Oct-2015		Miller Yu		PROJECTION:		
REV	DATE	FILE	BY				

1

2

3

4

5

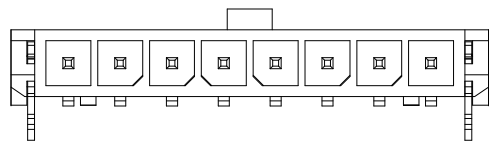

8P

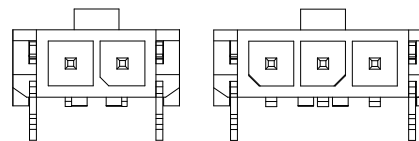

2P

3P

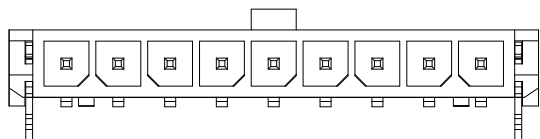

9P

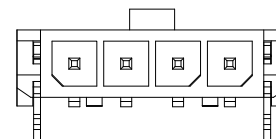

4P

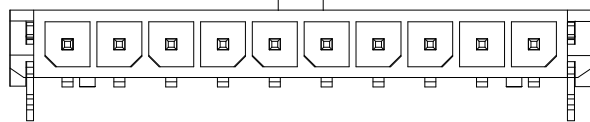

10P

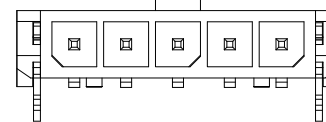

5P

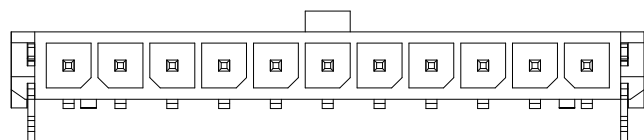

11P

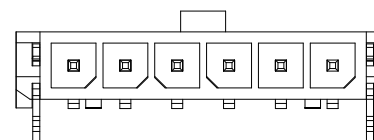

6P

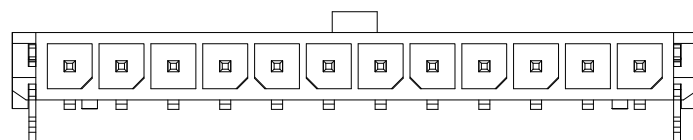

12P

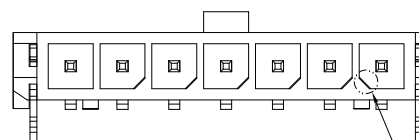





7P

此為防呆

5561RA-XXX-SM (2-12)Pin防呆位置分部示意圖

RoHS Compliant

F				DRAWN: Miller Yu	GENERAL TOLERANCE: .X=±0.20 .XX=±0.15	 Neltron Industrial Co., Ltd.	SIZE
E							
D				CHECKED: Jerry Chen	UNIT: MM	DESCRIPTION: 3.0mm Power Wafer Protection key Drawing	A4
C	28-May-2024		Lucy Du		SCALE: 1:1		
B	13-Jan-2023	 add Selective Gold Plated Option	Andrew	APPROVAL: Mike Wu	SHEET: 2/2	PART NO: 5561RA-XXX-SM-XX	
A	29-Oct-2015		Miller Yu		PROJECTION: 		
REV	DATE	FILE	BY				

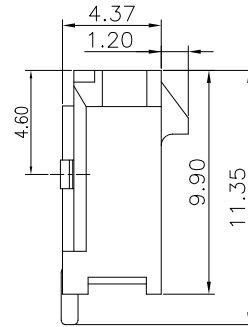
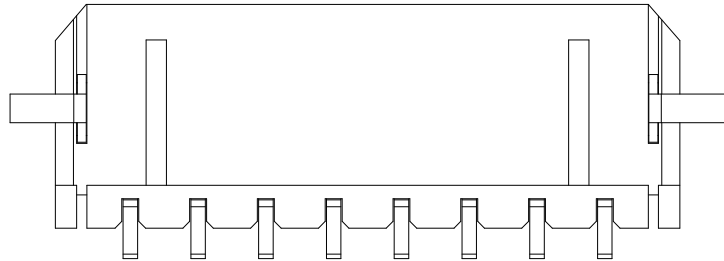
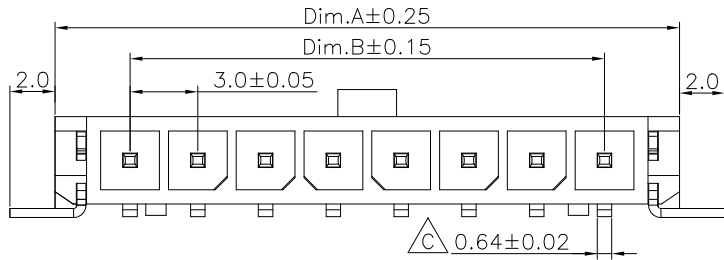

Specifications:
 Current Rating: 5.0A AC,DC
 Voltage Rating: 250V AC,DC
 Contact Resistance: 10m ohm.Max
 Insulation Resistance: 1000M ohm.Min
 Withstanding Voltage: 1500V AC/Minute
 Operating Temperature Range:-40°C ~ +125°C

Material:
 Insulator: LCP(UL94V-0)
 Insulator Color: Black
 Contact: Copper Alloy
 Plated: Gold or Tin or Selective Gold Plated \triangle_B

How To Order
 5561RA-XXX-SM1-XX
 Blank Tray
 TR:Tape&Reel
 SMD Type
 G:Gold Plated
 T:Tin Plated
 SG15:Selective Gold Plated 15u"
 SG30:Selective Gold Plated 30u"
 No. of Contacts
 Right Angle Type

Positions	Dimension			Positions	Dimension		
	A	B	C		A	B	C
2	9.65	3.00	14.20	8	27.65	21.00	32.20
3	12.65	6.00	17.20	9	30.65	24.00	35.20
4	15.65	9.00	20.20	10	33.65	27.00	38.20
5	18.65	12.00	23.20	11	36.65	30.00	41.20
6	21.65	15.00	26.20	12	39.65	33.00	44.20
7	24.65	18.00	29.20				

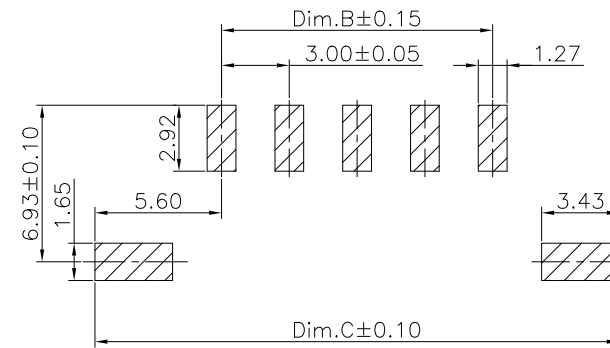

P.C.B Layout

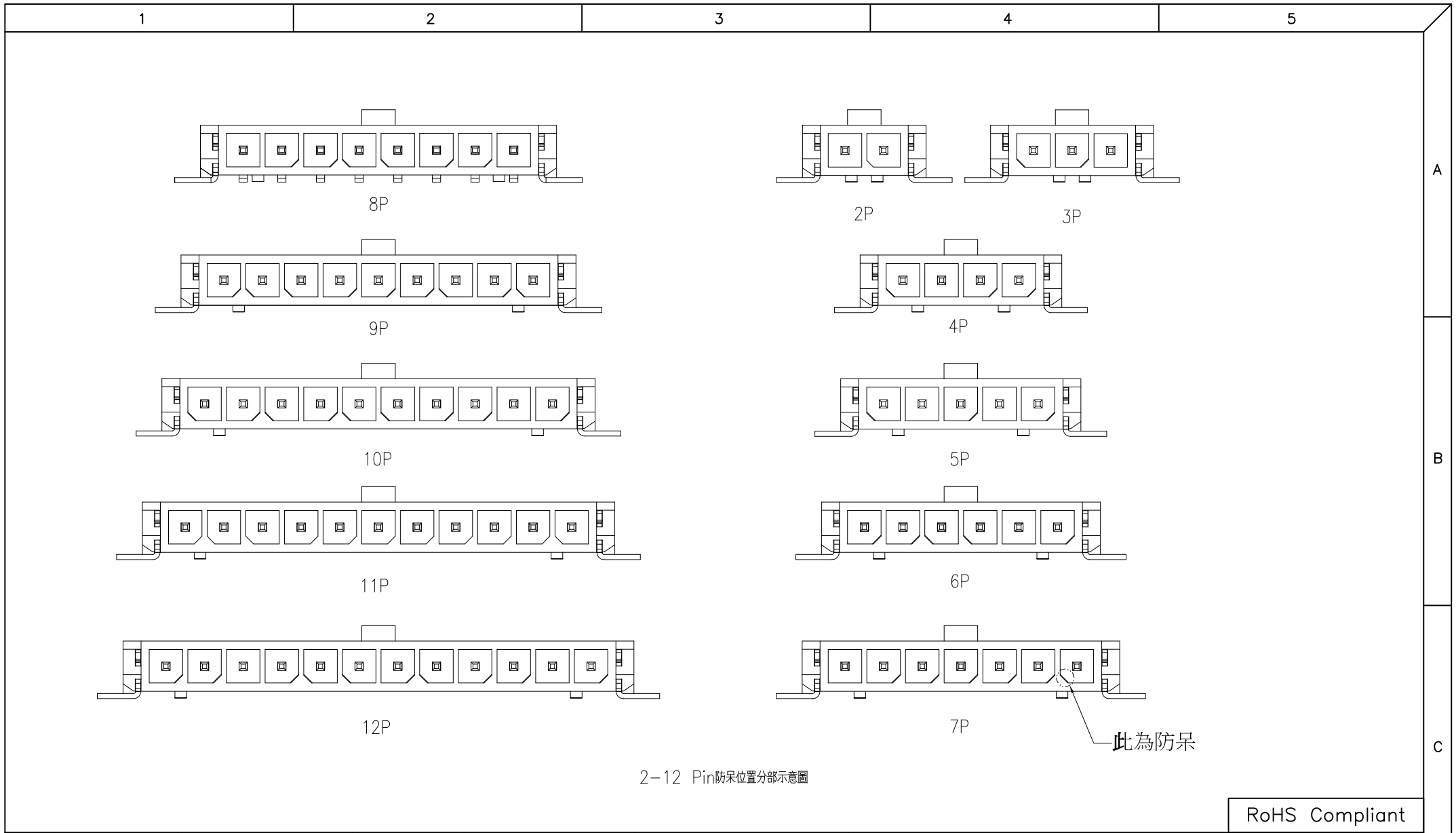

RoHS Compliant

F				DRAWN:	GENERAL TOLERANCE:	Neltron Industrial Co., Ltd.	SIZE
E				Jamie Wang	.X=±0.20 .XX=±0.15		
D				CHECKED:	UNIT: MM	DESCRIPTION:	A4
C	28-May-2024	\triangle_C	Lucy Du	Jerry Chen	SCALE: 1:1	3.0mm Pitch Power Wafer SMD Type	
B	13-Jan-2023	\triangle_B add Selective Gold Plated Option	Andrew		SHEET: 1/2	PART NO:	
A	13-Mar-2017		Jamie Wang	APPROVAL:	PROJECTION:	5561RA-XXX-SM1-XX	
REV	DATE	FILE	BY	Mike Wu			



2-12 Pin防呆位置分部示意圖

RoHS Compliant

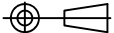
F				DRAWN: Jamie Wang	GENERAL TOLERANCE: .X=±0.20 .XX=±0.15	 Neltron Industrial Co., Ltd.	DESCRIPTION: 3.0mm Power Wafer Protection Key Drawing	SIZE A4
E								
D				CHECKED: Jerry Chen	UNIT: MM	PART NO: 5561RA-XXX-SM1-XX		
C	28-May-2024		Lucy Du		SCALE: 1:1			
B	13-Jan-2023	 add Selective Gold Plated Option	Andrew	APPROVAL: Mike Wu	SHEET: 2/2			
A	13-Mar-2017		Jamie Wang		PROJECTION: 			
REV	DATE	FILE	BY					

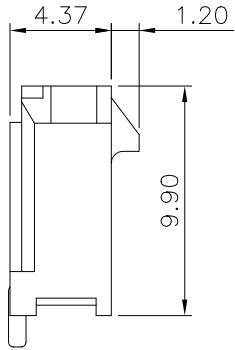
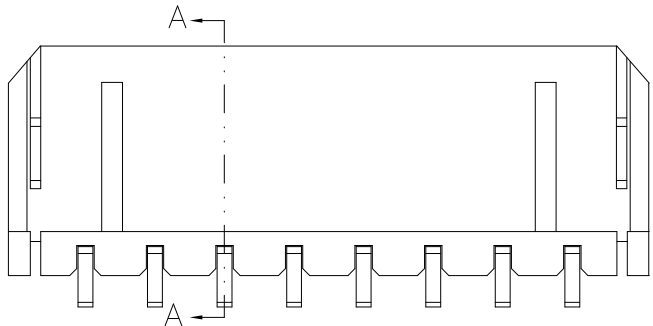
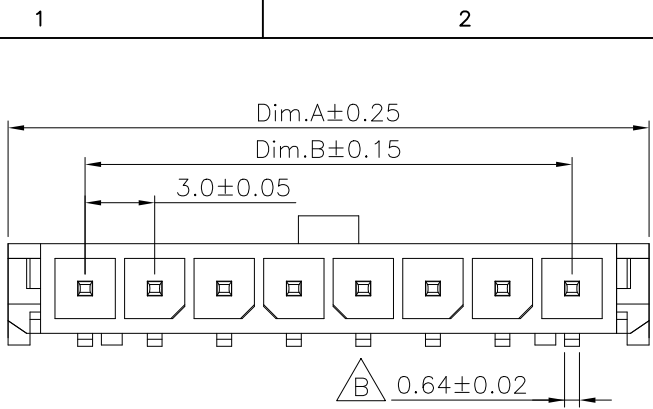

Specifications:
 Current Rating: 5.0A AC,DC
 Voltage Rating: 250V AC,DC
 Contact Resistance: 10m ohm.Max
 Insulation Resistance: 1000M ohm.Min
 Withstanding Voltage: 1500V AC/Minute
 Operating Temperature Range: -25°C ~ +105°C

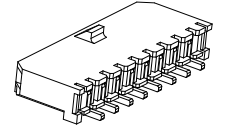

Material:
 Insulator: High Temp. Plastic (UL94V-0)
 Insulator Color: Black
 Contact: Copper Alloy
 Plated: Tin Plated

How To Order
 5561RA-XXT-SM1-01-XX
 Blank Tray
 TR:Tape&Reel
 Without Ear
 SMD Type
 Tin Plated
 No. of Contacts
 Right Angle Type

Positions	Dimension			Positions	Dimension		
	A	B	C		A	B	C
2	9.65	3.00	14.20	8	27.65	21.00	32.20
3	12.65	6.00	17.20	9	30.65	24.00	35.20
4	15.65	9.00	20.20	10	33.65	27.00	38.20
5	18.65	12.00	23.20	11	36.65	30.00	41.20
6	21.65	15.00	26.20	12	39.65	33.00	44.20
7	24.65	18.00	29.20				

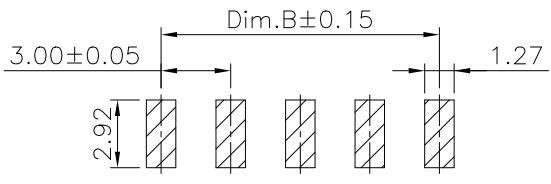

P.C.B Layout

RoHS Compliant

F				DRAWN:
E				Jamie Wang
D				CHECKED:
C				Jerry Chen
B	28-May-2024		Lucy Du	APPROVAL:
A	25-Apr-2016		Jamie Wang	Mike Wu
REV	DATE	FILE	BY	



GENERAL TOLERANCE:
.X=±0.20 .XX=±0.15
UNIT: MM
SCALE: 1:1
SHEET: 1/2
PROJECTION:

Neltron Industrial Co., Ltd.	
DESCRIPTION:	3.0mm Wafer Single Row SMD Type
PART NO:	5561RA-XXT-SM1-01-XX

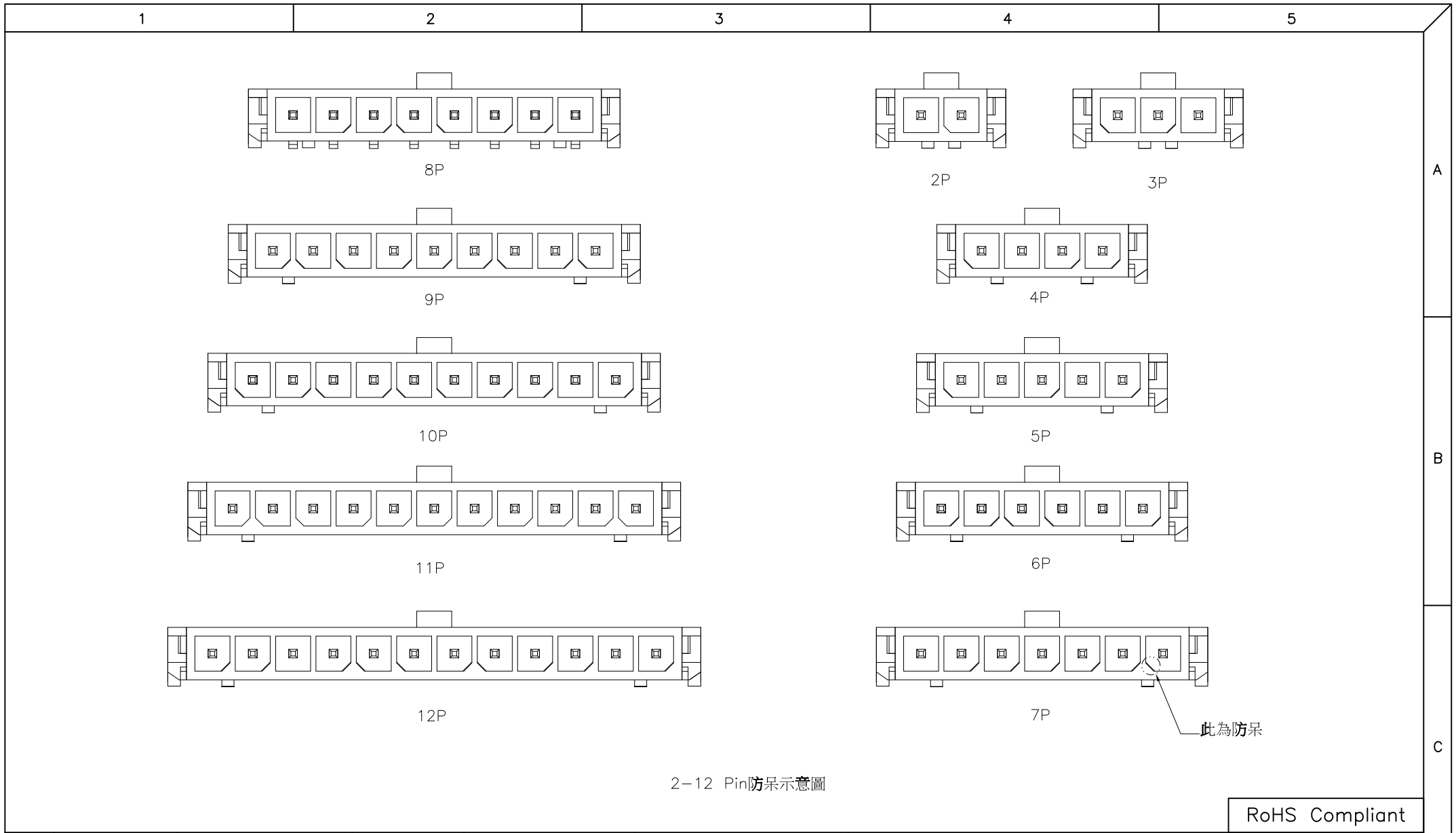
SIZE
A4

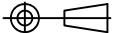

RoHS Compliant

F				DRAWN: Jamie Wang	GENERAL TOLERANCE: .X=±0.10 .XX=±0.05 .XXX=±0.03	 Neltron Industrial Co., Ltd.	DESCRIPTION: 3.0mm Power Wafer Protection Key Drawing	SIZE A4
E								
D				CHECKED: Jerry Chen	UNIT: MM	PART NO: 5561RA-XXT-SM1-01-XX		
C					SCALE: 1:1			
B	28-May-2024		Lucy Du	APPROVAL: Mike Wu	SHEET: 2/2			
A	25-Apr-2016		Jamie Wang		PROJECTION: 			
REV	DATE	FILE	BY					

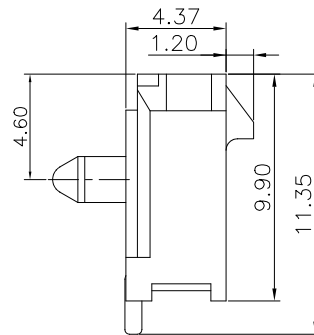
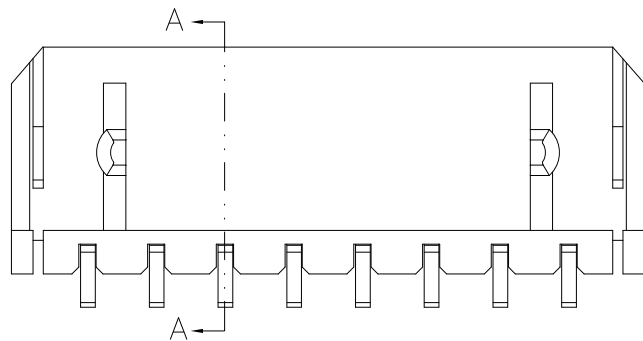
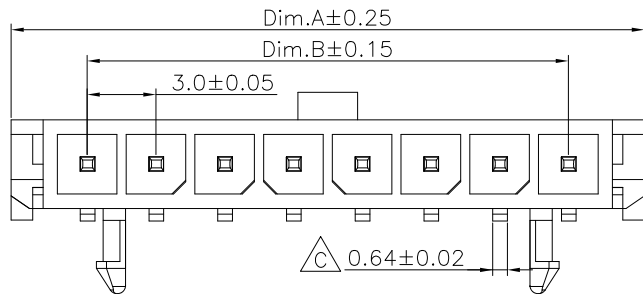

Specifications:
 Current rating:5.0A AC,DC
 Voltage rating:250V AC,DC
 Contact resistance:10mohm Max
 Insulation resistance:1,000Mohm min.
 Withstanding voltage:1,500V AC;DC
 Operating Temperature range:-40°C ~ +105°C

Materials and Finish:
 Insulator:LCP (UL94V-0)
 Insulator Color:Black
 Contact:Copper Alloy
 Plating:Tin or Selective Gold Plated $\triangle B$

How to order
 5561RA-XXX-SM2-XX

- Blank Tube
- TR:Tape & Reel
- SMD Type
- T:Matte Tin Plated
- SG15:Selective Gold Plated 15u"
- SG30:Selective Gold Plated 30u"
- No. Of Contacts
- Right Angle

Positions	Dimension			Positions	Dimension		
	A	B	C		A	B	C
2	9.65	3.00		8	27.65	21.00	16.70
3	12.65	6.00		9	30.65	24.00	19.70
4	15.65	9.00	4.70	10	33.65	27.00	22.70
5	18.65	12.00	7.70	11	36.65	30.00	25.70
6	21.65	15.00	10.70	12	39.65	33.00	28.70
7	24.65	18.00	13.70				

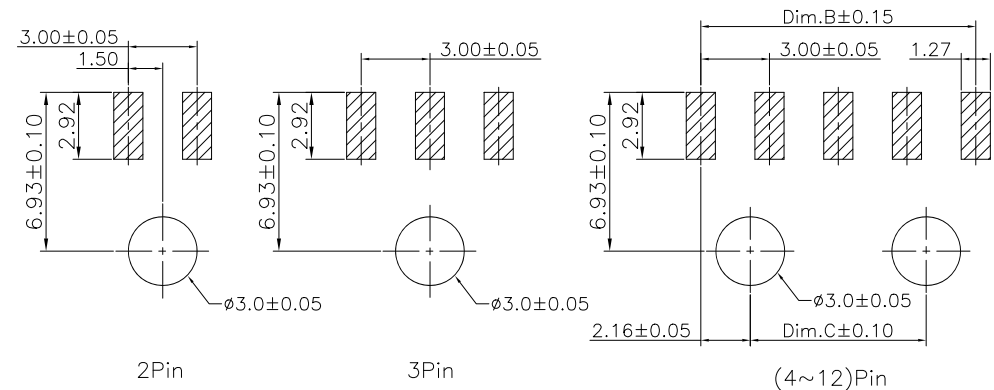

PCB LAYOUT

RoHS Compliant

F				DRAWN:	
E				Pingchia	
D				CHECKED:	
C	28-May-2024	$\triangle C$	Lucy Du	Jerry Chen	
B	13-Jan-2023	$\triangle B$ add Selective Gold Plated Option	Andrew		
A	18-Oct-2016		Pingchia	APPROVAL:	
REV	DATE	FILE	BY	Mike Wu	

GENERAL TOLERANCE:	.X=±0.20 .XX=±0.15
UNIT: MM	
SCALE:1:1	
SHEET: 1 / 2	
PROJECTION:	

Neltron Industrial Co., Ltd.	
DESCRIPTION:	3.0mm Wafer Single Row SMD Type
PART NO:	5561RA-XXX-SM2-XX

SIZE	A4
------	-----------

1

2

3

4

5

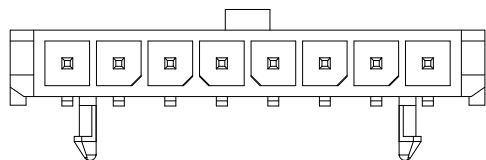

8P

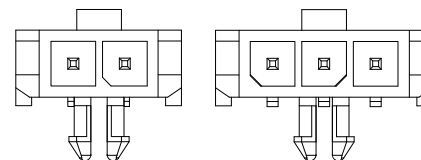

2P

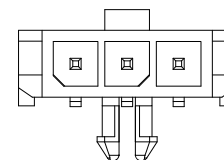

3P

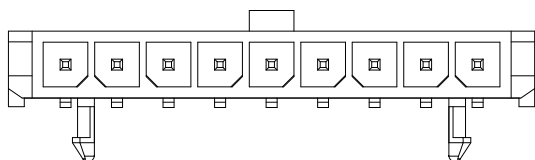

9P

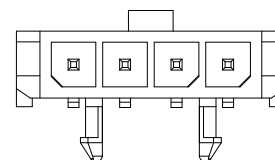

4P

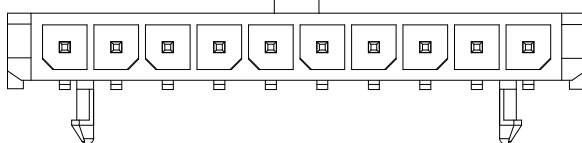

10P

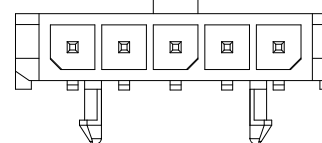

5P

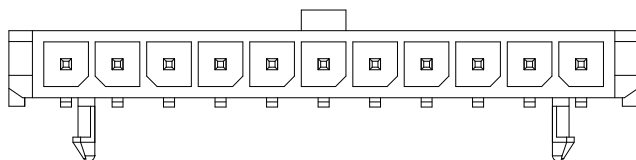

11P

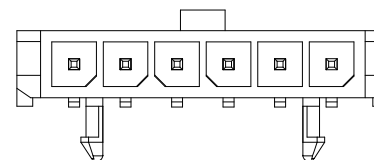

6P

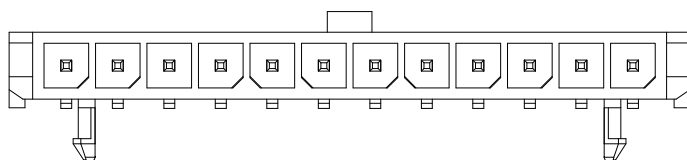

12P

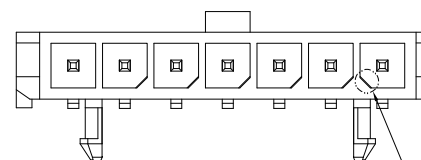



7P

此為防呆

5561RA-XXX-SM2 (2-12)Pin防呆位置分部示意圖

RoHS Compliant

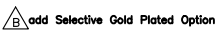
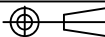
F				DRAWN: Pingchia	GENERAL TOLERANCE: .X=±0.10 .XX=±0.05 .XXX=±0.03	 Neltron Industrial Co., Ltd.	DESCRIPTION: 3.0mm Wafer Single Row 90° Type	SIZE
E								
D				CHECKED: Jerry Chen	UNIT: MM	PART NO: 5561RA-XXX-SM2-XX	SIZE A4	
C	28-May-2024		Lucy Du		SCALE:1:1			
B	13-Jan-2023		Andrew	APPROVAL: Mike Wu	SHEET: 2/2			
A	18-Oct-2016		Pingchia		PROJECTION: 			
REV	DATE	FILE	BY					