

active

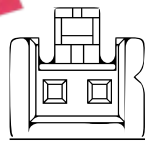

2 PIN

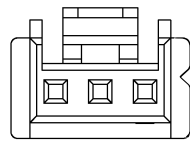

3 PIN

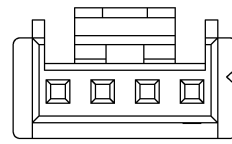

4 PIN

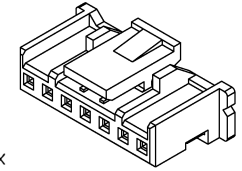

Specifications:
 Current Rating:3.0A AC,DC
 Voltage Rating:250V AC,DC
 Contact Resistance:20m ohm.Max
 Insulation Resistance:1000M ohm.Min
 Withstanding Voltage:800V AC/Minute
 Operating Temperature Range:-25°C~+85°C
 Application Wire:Awg#24~#28

Material:
 Insulator:Thermoplastic(UL94V-0)
 Insulator Color:White
 Contact:Copper Alloy

How To Order
 2418HZ-XX
 └───┬─── No. of Contacts
 └───┴─── Housing

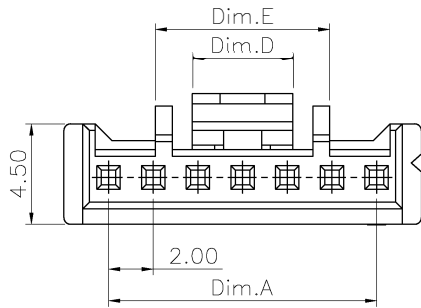

5~15 PIN

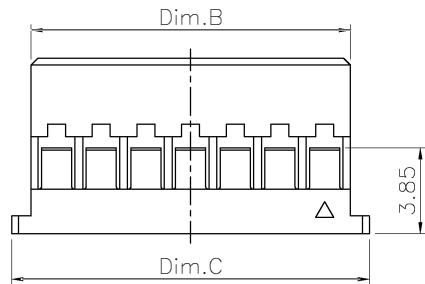
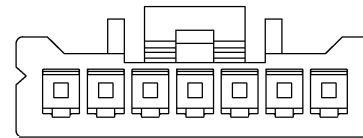
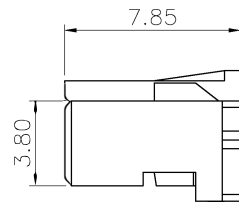

Dimension Information:

Pos	Dim.A	Dim.B	Dim.C	Dim.D	Dim.E	Pos	Dim.A	Dim.B	Dim.C	Dim.D	Dim.E
02	2.00	4.30	6.00	2.00	/	10	18.00	20.30	22.00	11.00	14.30
03	4.00	6.30	8.00	3.35		11	20.00	22.30	24.00		
04	6.00	8.30	10.00	4.50		12	22.00	24.30	26.00		
05	8.00	10.30	12.00	4.50	7.80	13	24.00	26.30	28.00		
06	10.00	12.30	14.00			14	26.00	28.30	30.00		
07	12.00	14.30	16.00	4.50	7.80	15	28.00	30.30	32.00		
08	14.00	16.30	18.00			15	28.00	30.30	32.00		
09	16.00	18.30	20.00			15	28.00	30.30	32.00		

RoHS Compliant

F				DRAWN: ZONGYI	GENERAL TOLERANCE: .X=±0.20 .XX=±0.15	Neltron Industrial Co., Ltd.	DESCRIPTION: 2.0mm Wire To Board Housing	SIZE A4
E								
D				APPROVAL: MIKE	SCALE: 1:1	PART NO: 2418HZ-XX		
C					PROJECTION:			
B	10-AUG-2023	Add Packing List	LUCY					
A	13-NOV-2019		ZONGYI					
REV	DATE	FILE	BY					

1

2

3

4

5

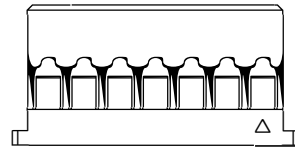
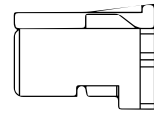
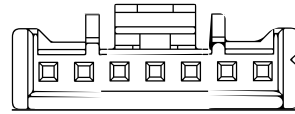

2418HZ-XX

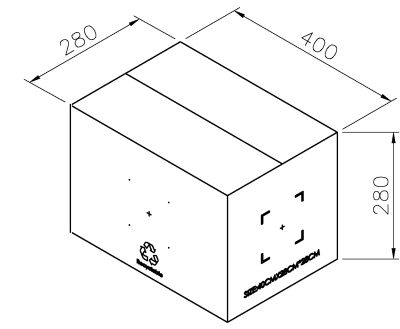
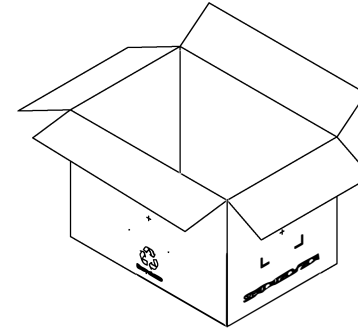
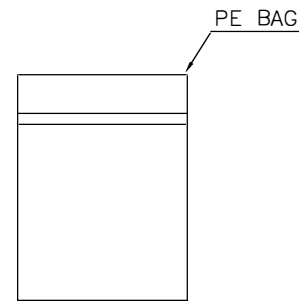

Carton

Note:

- 1.Dimension:
Carton Size:400*280*280 (mm)
- 2.Quantity:
XX Pcs/Bag
XXX Pcs/Carton

Pin	Pcs/Bag	Pcs/Carton	Pin	Pcs/Bag	Pcs/Carton
2	1000	70000	9	1000	8000
3	1000	50000	10	1000	8000
4	1000	50000	11	1000	8000
5	1000	30000	12	1000	6000
6	1000	10000	13	1000	6000
7	1000	10000	14	1000	6000
8	1000	10000	15	1000	5000

RoHS Compliant

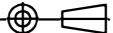
F				DRAWN:	GENERAL TOLERANCE:	 Neltron Industrial Co., Ltd.	SIZE
E				ZONGYI	.X=±0.20 .XX=±0.15		
D				CHECKED:	UNIT: MM	DESCRIPTION: 2.0mm Wire To Board Housing Packing List	A4
C				RORY	SCALE:		
B	10-AUG-2023	Add Packing List	LUCY	APPROVAL:	SHEET: 2/2	PART NO: 2418HZ-XX	
A	13-NOV-2019		ZONGYI	MIKE	PROJECTION: 		
REV	DATE	FILE	BY				