

未注公差/General tolerances(mm)											0.1/10		
0	>3	>6	>10	>18	>30	>50	>80	>120	>180	>250		>315	>400
~3	~6	~10	~18	~30	~50	~80	~120	~180	~250	~315	~400	~500	~2.50
±0.12	±0.18	±0.22	±0.26	±0.31	±0.37	±0.57	±0.80	±0.93	±1.05	±1.15	±1.60	±2.20	±2.50

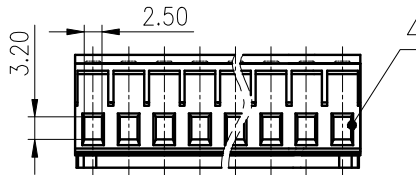
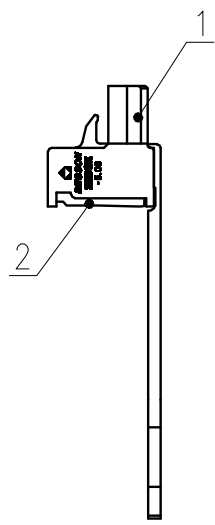
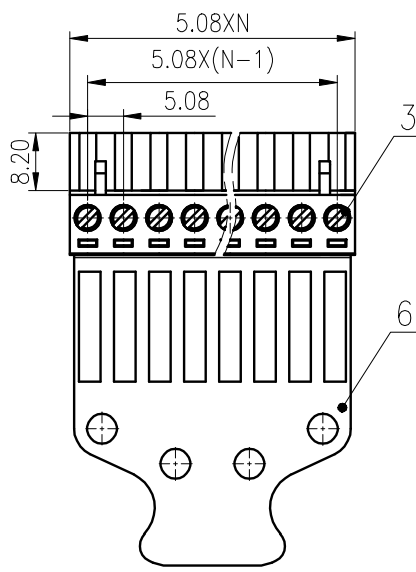
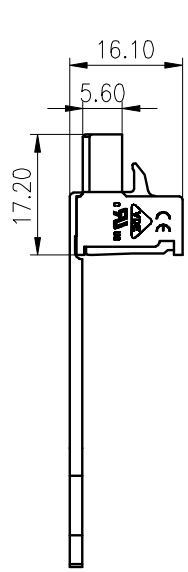
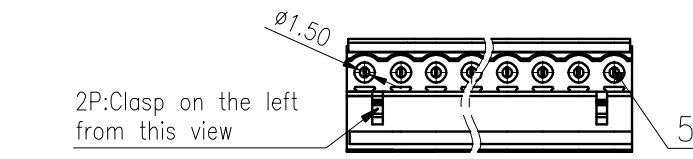
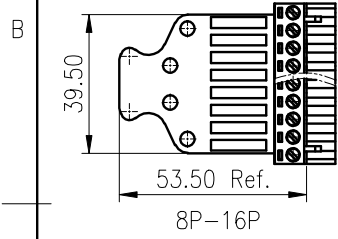
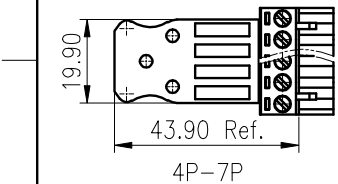
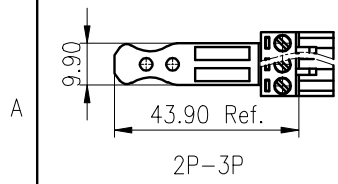

6	Housing 2	PA66	UL94V-0
5	Clamp	Copper Alloy	Sn Plated
4	Cage	Copper Alloy	M2.5/Ni Plated
3	Screw	Steel	M2.5/Zn Plated
2	Cover	PA66	UL94V-0
1	Housing 1	PA66	UL94V-0

ITEM	NAME OF PART	MATERIAL	NOTES
UL 标准/UL Standard:		B	C
额定电压/电涌/Rated Voltage(V)/Current(A)		300/15	300/10
IEC 标准/IEC Standard:			
过压类别/Overvoltage Category/污染等级/Pollution Degree		III/3	III/2 II/2
额定电压/电涌/Rated Voltage(V)/Current(A)		/	320/20
额定脉冲电压(kV)/Rate Impulse Voltage(kV)		/	4
螺丝扭矩/Torque Tightening(N·m/Lb.in)		M2.5, 0.4/3.54	
线径范围(硬线和软线)/Wire Range(rigid and flexible)(mm <sup>2</sup> /AWG)		1.0~2.5/28~12	
间距/Pitch(mm)/线数范围/Poles		5.08/N=02~16P	
剥线长度/Stripping length(mm)		7-8	
使用温度范围/Operating temperature(°C)		-40~+105	
符合RoHS环保要求/Conform to RoHS		Yes	

MATERIAL: /	SURFACE: /		
MAT NO.: /	<b>宁波高松电子有限公司</b> <b>NINGBO DEGSON ELECTRICAL CO., LTD</b>		
STATUS: /			
APPD: LanCH 2020.06.23	NAME: 2EDGKE-5.08-XXP-1Y-00A(H)		
CHKD: YuJZ 2020.06.23	DRAWING NO.: 2EDGKE-5.08-C01		
DRFT: WNK 2019.03.15	REV	T1	
⊕	SIZE: A4	TYPE: CUSTOMER DRAWING	SCALE: 1:1 SHEET 1/1



REV	ECN	DESCRIPTION	DRFT	DATE