

02P

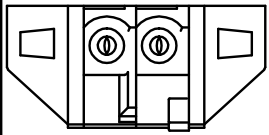

03P

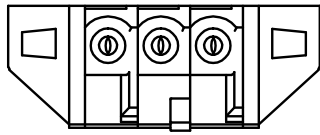

未注公差/General tolerances(mm)											0.1/10		
0	>3	>6	>10	>18	>30	>50	>80	>120	>180	>250			
~3	~6	~10	~18	~30	~50	~80	~120	~180	~250	~315	~400	~500	~2.50
±0.12	±0.18	±0.22	±0.26	±0.31	±0.37	±0.57	±0.80	±0.93	±1.05	±1.15	±1.60	±2.20	±2.50

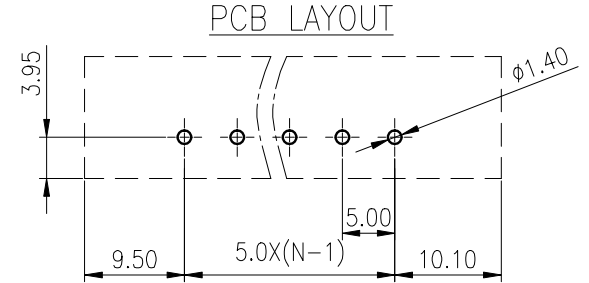

Bending the pin-header after assembling

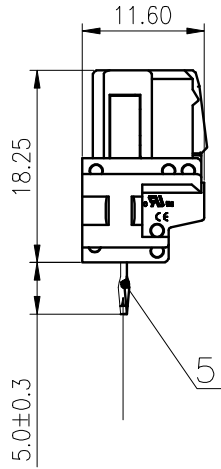
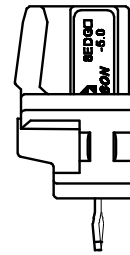
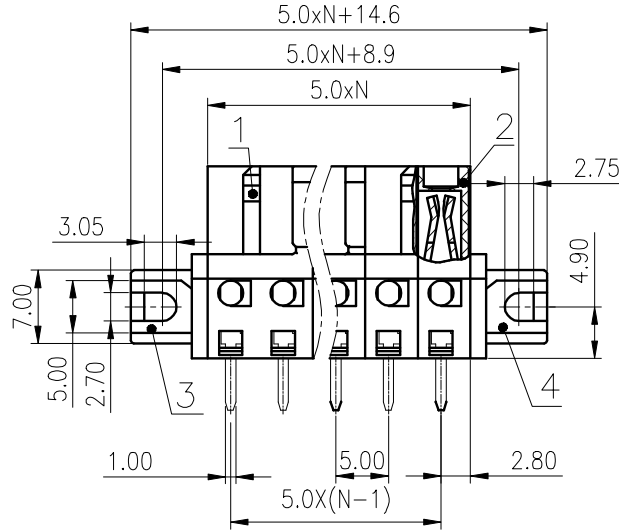
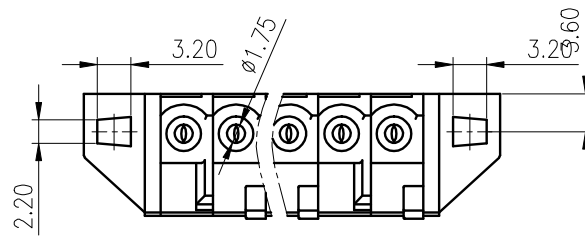

The first pin will bulge to the left

5	Clamp	Copper alloy	Sn Plated
4	Right housing	PA66	UL94V-0
3	Left housing	PA66	UL94V-0
2	Housing2	PA66	UL94V-0
1	Housing1	PA66	UL94V-0
ITEM	NAME OF PART	MATERIAL	NOTES
UL 标准/UL Standard:		B	C
额定电压/电涌/Rated Voltage(V)/Current(A)		300/15	300/10
IEC 标准/IEC Standard:			
过压类别/Overvoltage Category/污染等级/Pollution Degree		III/3	III/2 II/2
额定电压/电涌/Rated Voltage(V)/Current(A)		320/20	/ /
额定脉冲电压(KV)/Rate Impulse Voltage(KV)		4.0	/ /
线径范围(硬线和软线)/Wire Range(rigid and flexible)(mm ² /AWG)		/	
间距/Pitch(mm)/线数范围/Poles		5.0/N=02~24P	
剥线长度/Stripping length(mm)		6-7	
使用温度范围/Operating temperature(°C)		-40~+105	
符合RoHS环保要求/Conform to RoHS		Yes	
标准颜色编号/Standard color number:		PANTONE 428C	
PANTONE / RAL			

MATERIAL: /	SURFACE: /		
MAT NO.: /	宁波高松电子有限公司 NINGBO DEGSON ELECTRICAL CO., LTD		
STATUS: /			
APPD:	NAME: 8EDGDM-5.0-XXP-11-01A(H)		
CHKD:			
DRFT: WangY1 2020.06.19	DRAWING NO.: 8EDGBM-5.0-C02		REV TO
④	SIZE: A4	TYPE: CUSTOMER DRAWING	SCALE: 2:1 SHEET 1/1



REV	ECN	DESCRIPTION	DRFT	DATE