

02P

03P

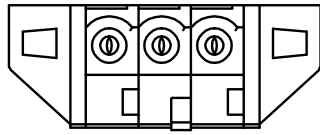

公差/General tolerances(mm)														
0	>3	>6	>10	>18	>30	>50	>80	>120	>180	>250	>315	>400	>500	0.1/10 ±2'
~3	~6	~10	~18	~30	~50	~80	~120	~180	~250	~315	~400	~500	±2.50	
±0.12	±0.18	±0.22	±0.26	±0.31	±0.37	±0.57	±0.80	±0.93	±1.05	±1.15	±1.60	±2.20	±2.50	

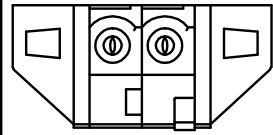
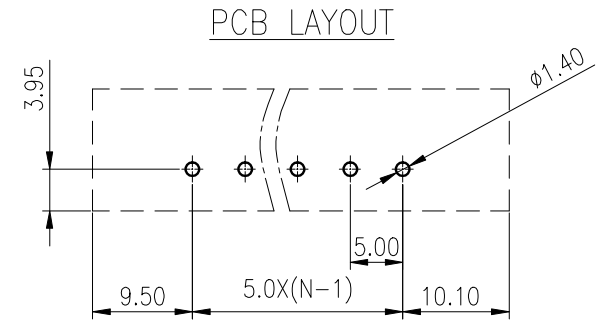

Bending the pin-header after assembling

ITEM	NAME OF PART	MATERIAL	NOTES
5	Clamp	Copper	Sn Plated
4	Right housing	PA66	UL94V-0
3	Left housing	PA66	UL94V-0
2	Housing2	PA66	UL94V-0
1	Housing1	PA66	UL94V-0

UL 标准/UL Standard:	B	C	D
额定电压/电涌/Rated Voltage(V)/Current(A)	300/15	/	300/10
IEC 标准/IEC Standard:			
过压类别/Overvoltage Category/污染等级/Pollution Degree	III/3	III/2	II/2
额定电压/电涌/Rated Voltage(V)/Current(A)	320/20	/	/
额定脉冲电压(KV)/Rate Impulse Voltage(KV)	4.0	/	/
线径范围(硬线和软线)/Wire Range(rigid and flexible)(mm <sup>2</sup> /AWG)	/		
间距/Pitch(mm)/线数范围/Poles	5.0/N=02~24P		
剥线长度/Stripping length(mm)	6-7		
使用温度范围/Operating temperature(°C)	-40~+105		
符合RoHS环保要求/Conform to RoHS	Yes		
标准颜色编号/Standard color number: PANTONE / RAL	PANTONE 428C		

A

B

C

D

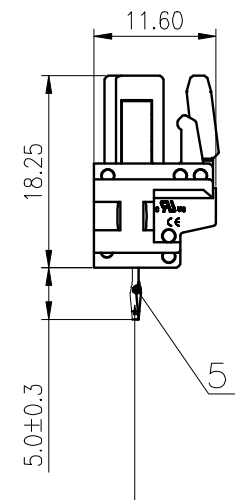

The first pin will bulge to the left

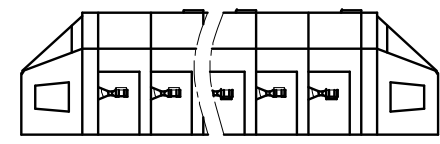
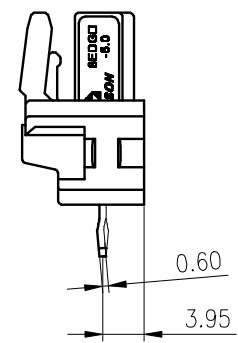
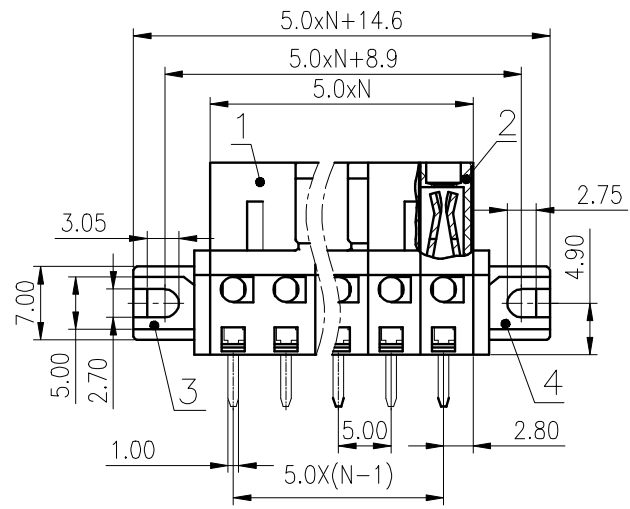
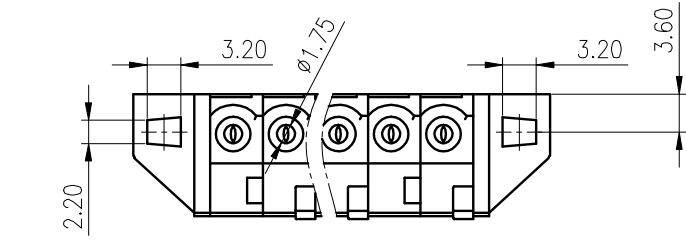

REV	ECN	DESCRIPTION	DRFT	DATE	SIZE: A4	TYPE: CUSTOMER DRAWING	SCALE: 2:1	SHEET 1/1

MATERIAL: /	SURFACE: /		
MAT NO.: /	<b>宁波高松电子有限公司</b> <b>NINGBO DEGSON ELECTRICAL CO., LTD</b>		
STATUS: /			
APPD:	NAME: <b>8EDGBM-5.0-XXP-11-01A(H)</b>		
CHKD:			
DRFT: WangY1 2020.06.19	DRAWING NO.: 8EDGBM-5.0-C02	REV	TO